

BRAZIL HØJSKAB

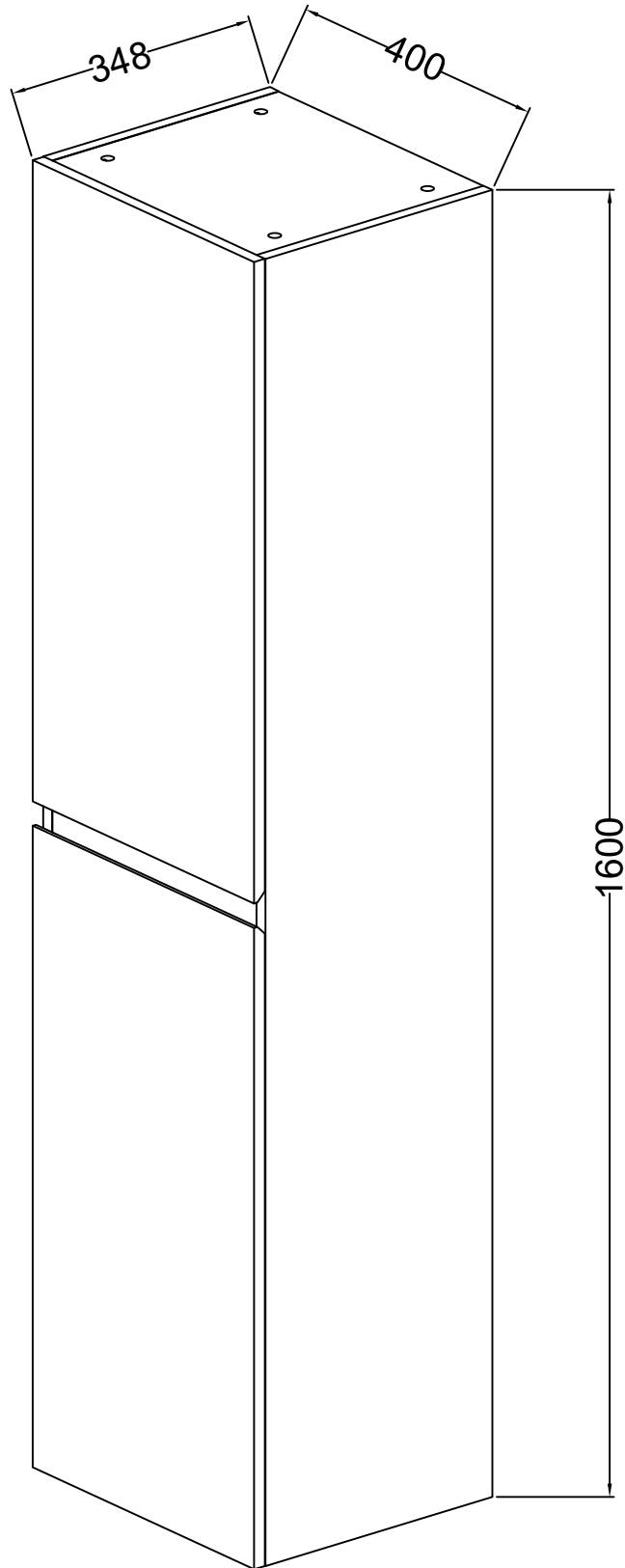

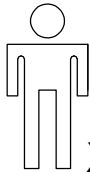







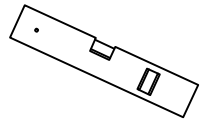
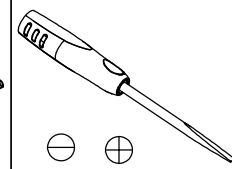
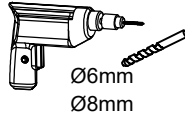
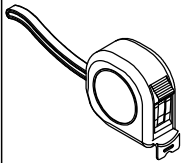
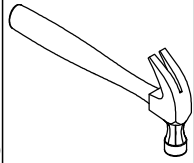







90 minutes

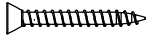

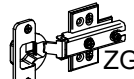
X2

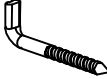

 SHY	 X14	 CBT	 X8	 TSK	X14	 KWGP	X14	 SJT	X2	 ZGLS-14	X12
 JD	X2	 ZB-35	X4	 DPZ	X2	 DGG	X2	 JS	X1		

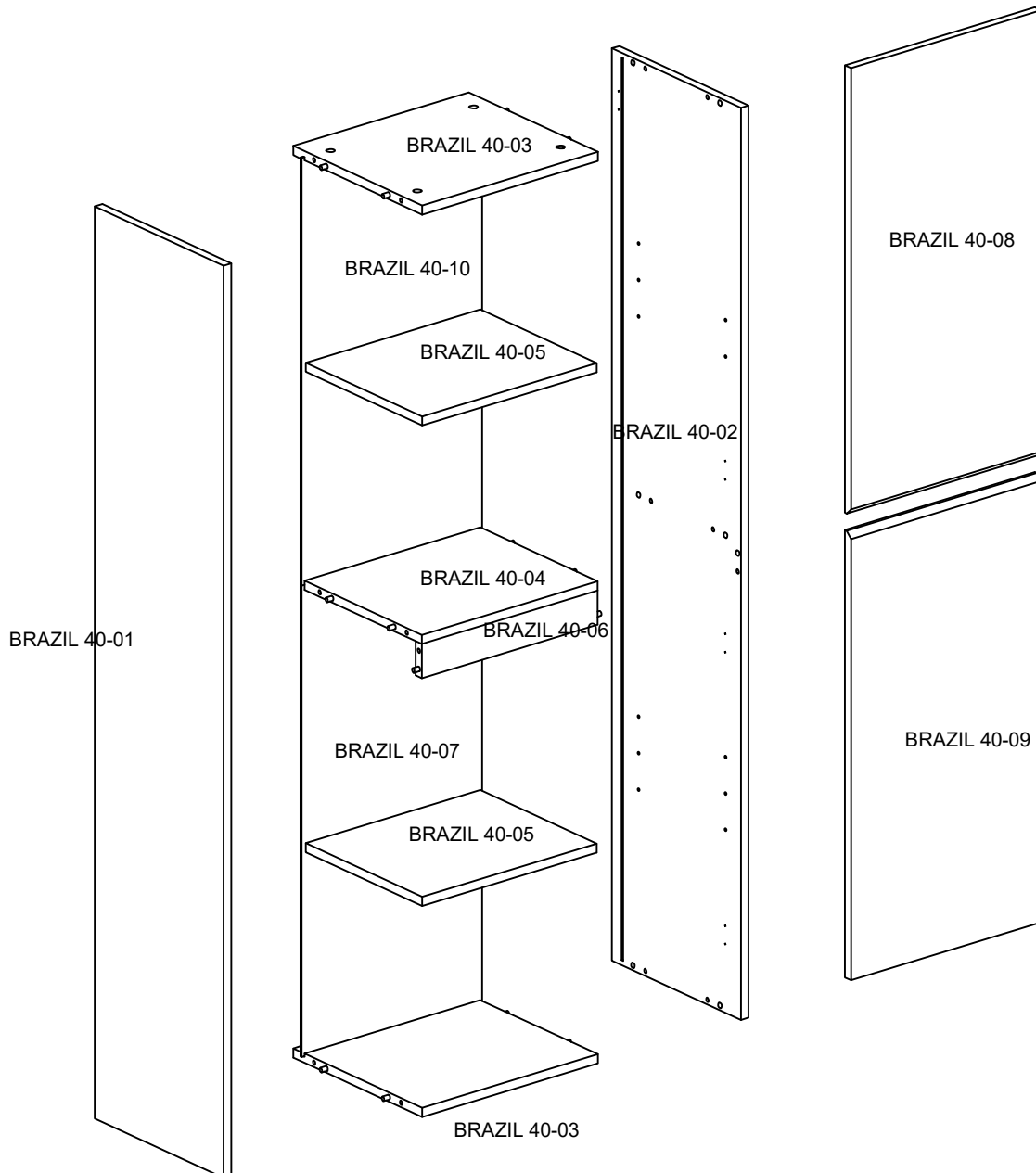

1



SHY



X14



CBT

X8

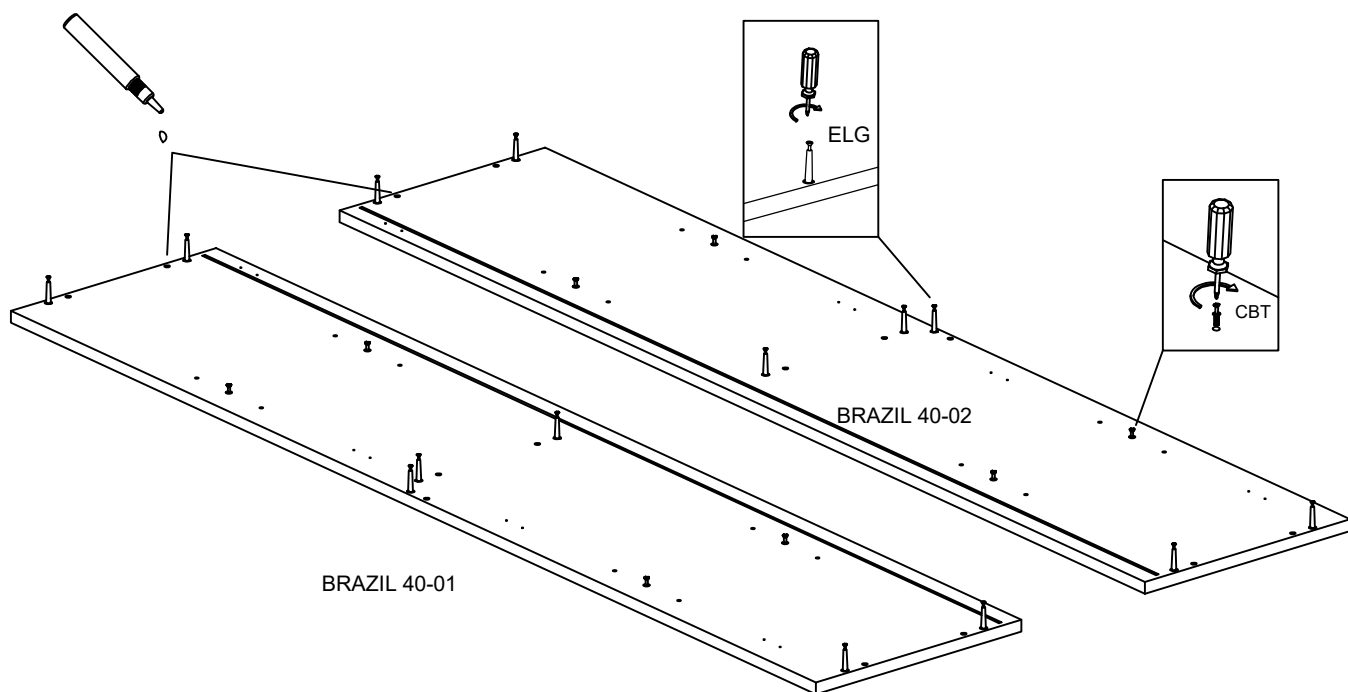

2



TSK

X7



KWGP

X7

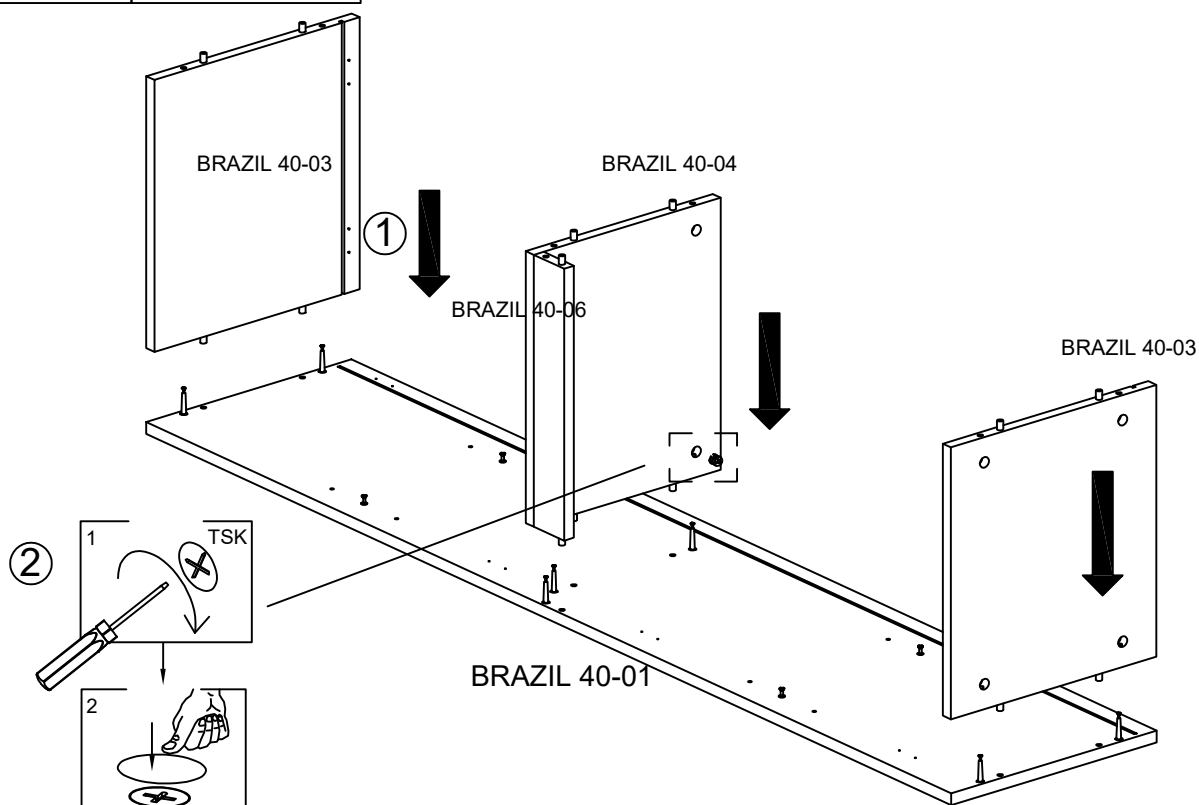

3



TSK

X7

KWGP

X7



X7

X7

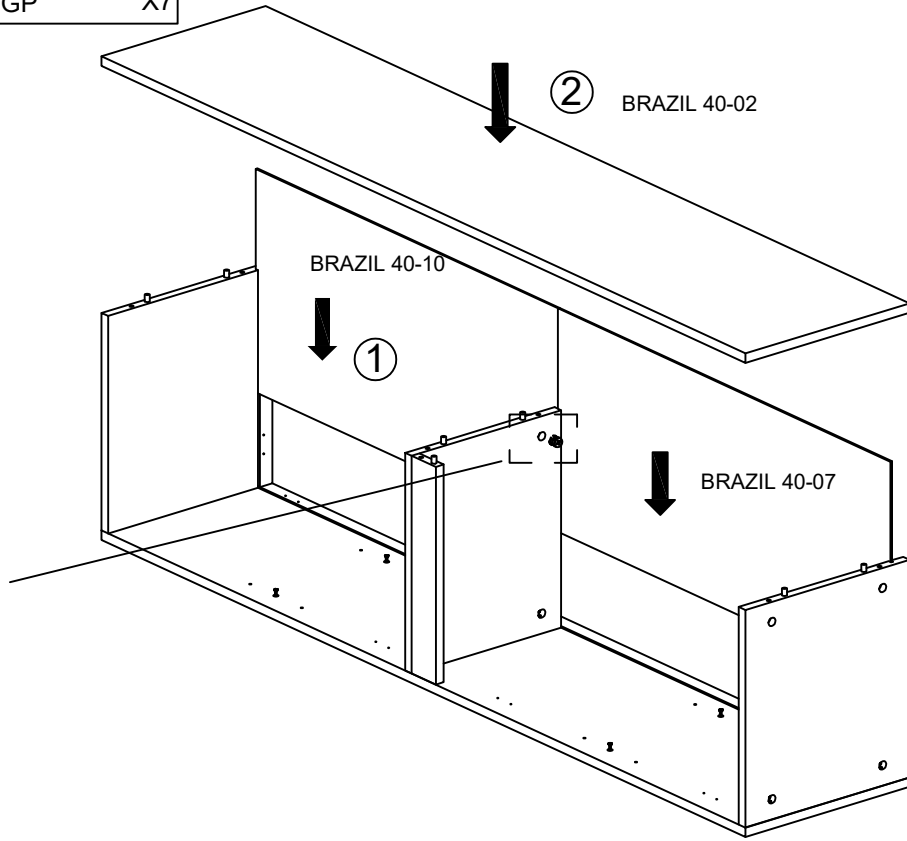
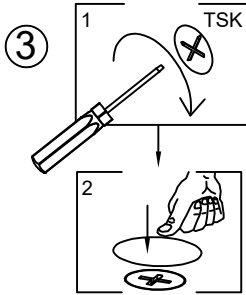

4



CBT

X8

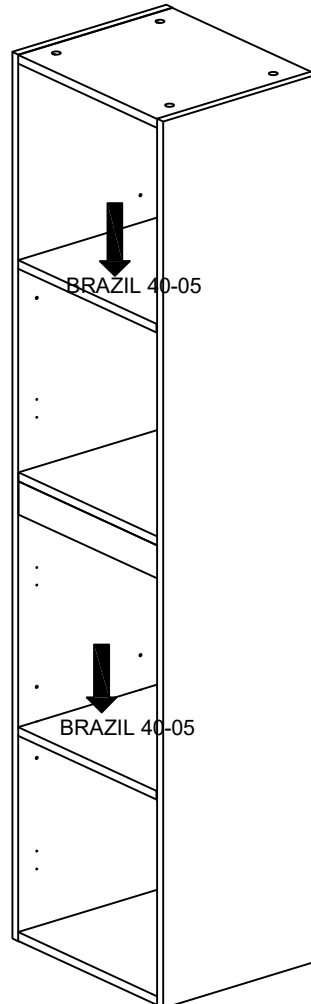
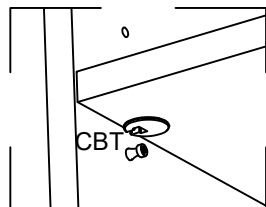
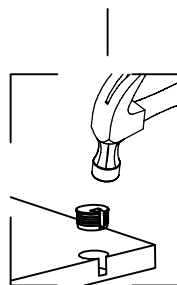
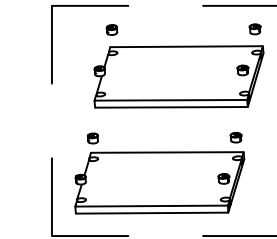

5



SJT

X2

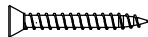

M 3.5x14

ZGLS-14

X12



JD

X2

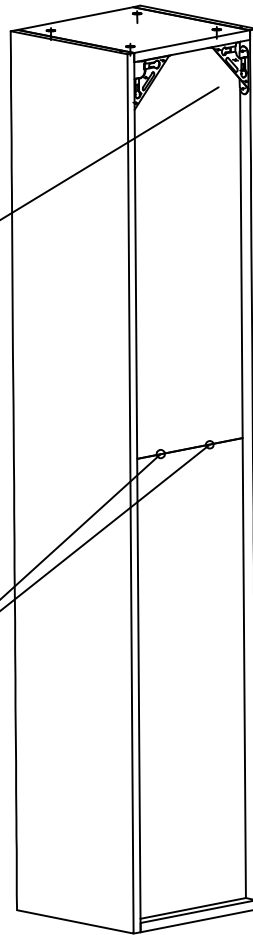
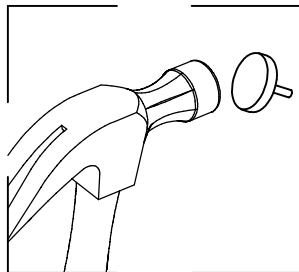
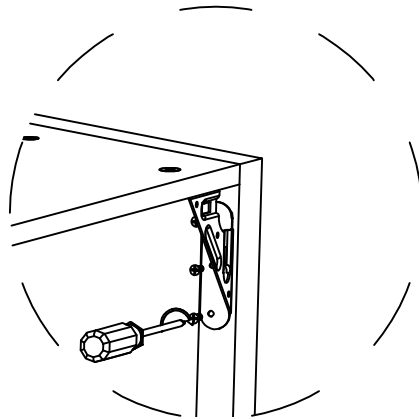

6

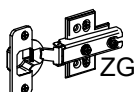

ZB-35

X4

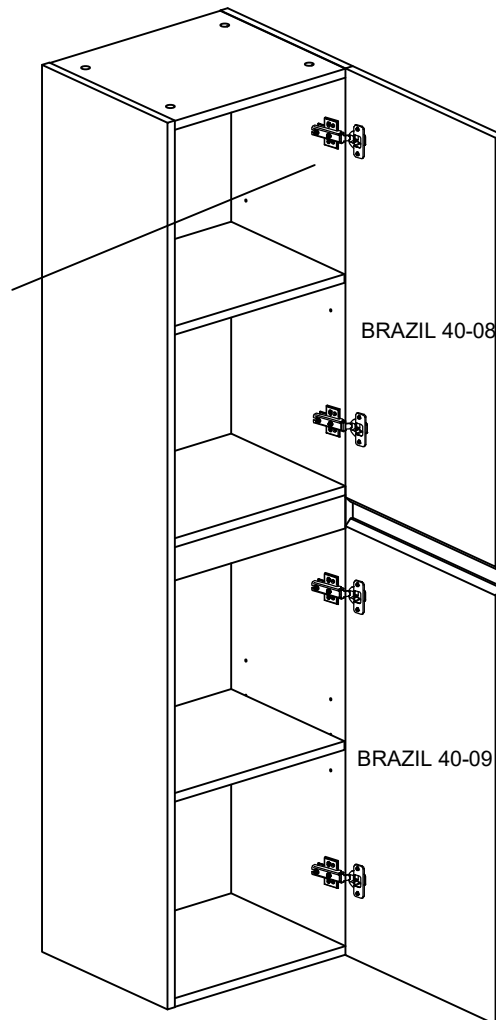
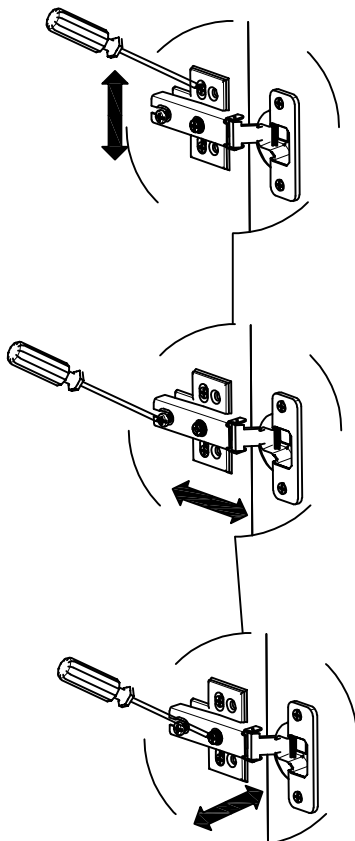

7



DPZ

X2

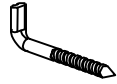

DGG

X2

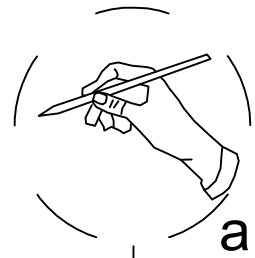
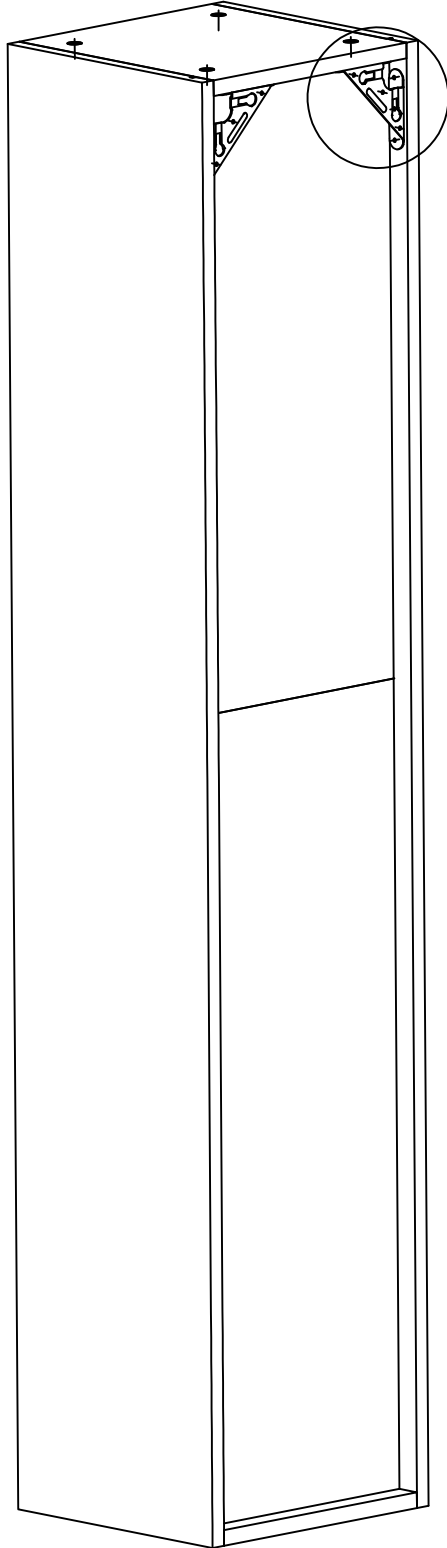

a

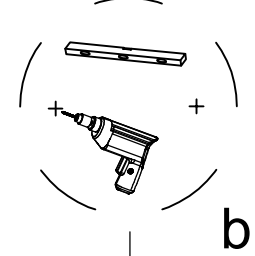

b

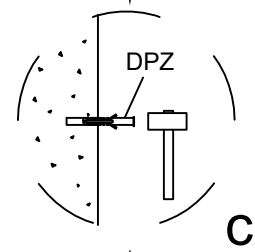

c

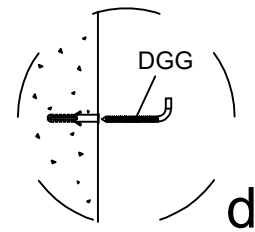

d

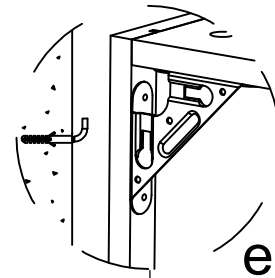

e

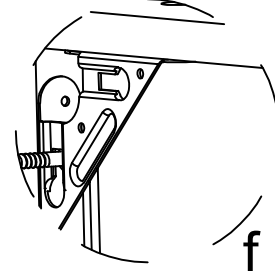

f